



# IRC MEASUREMENT MANUAL

[WWW.IRCRATING.ORG](http://WWW.IRCRATING.ORG)

Updated November 2022



# IRC MEASUREMENT MANUAL

## Table of Contents

1.	INTRODUCTION .....	3
2.	GENERAL ROLE OF AN IRC MEASURER .....	3
3.	RULES AND DOCUMENTATION .....	3
4.	EQUIPMENT .....	4
5.	ACCURACY.....	4
6.	TECHNIQUES .....	5
7.	PREVIOUS MEASUREMENTS.....	5
8.	WEIGHING .....	6
8.1	Weighing Equipment .....	6
8.2	Weighing Condition .....	6
8.3	Weighing Method.....	7
8.4	Alternative Weighing Methods.....	8
9.	HULL.....	8
9.1	LH – Hull Length .....	8
9.2	Hull Beam .....	8
9.3	Draft .....	9
9.4	Overhangs .....	11
10.	SPARS AND RIG .....	13
10.1	P, E, J and FL.....	13
10.2	STL .....	14
10.3	SPL.....	16
10.4	Aft Rigging .....	17
11.	SAILS.....	19
11.1	Spinnaker.....	20
11.2	Flying Headsail .....	20
11.3	Headsail.....	20
12.	PHOTOGRAPHY FOR RATINGS.....	23
13.	OTHER ISSUES.....	25
APPENDIX 1.	WEIGHING ON COMPRESSION LOAD CELLS .....	26
APPENDIX 2.	OVERHANGS & WEIGHING OF SUPERYACHTS .....	27
APPENDIX 3.	IRC ENDORSEMENT – PROCESS, MEASUREMENT & DATA STANDARDS ..	28
A3.1	Preamble .....	28
A3.2	Process.....	28
A3.3	Measuring Equipment.....	28
A3.3.1	Load Cells.....	28
A3.3.2	Linear Measurements .....	29
A3.4	Sources of Data .....	29
A3.4.1	General .....	29
A3.4.2	One Designs Previously Approved by the Rating Authority .....	30
A3.5	Retention of Endorsed Status.....	30
APPENDIX 4.	MAINSAIL MEASUREMENT.....	31
APPENDIX 5.	HEADSAIL & FLYING HEADSAIL MEASUREMENT .....	32
APPENDIX 6.	HEADSAIL FOOT OFFSET.....	34
APPENDIX 7.	SPINNAKER AND FLYING HEADSAIL MEASUREMENT .....	35
APPENDIX 8.	BULB WEIGHT MEASUREMENT .....	36
A8.1	Weigh the bulb.....	36
A8.2	Designer/builder declaration.....	38
A8.3	Volume measurement. ....	39
APPENDIX 9.	LEAD IN KEEL FINS .....	41
APPENDIX 10.	FOILS MEASUREMENT .....	41
APPENDIX 11.	LIST ANGLE MEASUREMENT.....	42
A11.1	Equipment.....	42
A11.2	Preparation .....	42
A11.3	Movable Ballast.....	43



## 1. INTRODUCTION

The guide is intended to ensure good and consistent measurement practice by IRC measurers around the world. In addition to describing each measurement, some of the common mistakes and errors are noted.

While the term 'measurer' will be used throughout, this should be taken to include 'official' measurers in addition to owner's self-measuring their own boats.

## 2. GENERAL ROLE OF AN IRC MEASURER

Official Measurers should note the following:

- The measurer's responsibility is to achieve a fair and accurate result, rather than the optimum result for the particular owner. While you are measuring a boat for the owner you are also acting on behalf of the rest of the fleet to ensure fair racing.
- A professional approach and attitude is very important. The owner is paying for your services, and wants to have confidence in the measurements you take, both on their own boat and also on their competitors' boats. The owner needs the confidence that you will be fair and accurate. In this context, if you are not sure refer to the rule book or contact the IRC Rating Authority (via your local IRC Rule Authority) for clarification.
- Always explain what you are doing and show the owner the measurement outcome, particularly if it you do not believe it is their favour. The owner may get an unpleasant surprise anyway when the certificate arrives; better that they should know there and then and understand why. Measurers should NOT however discuss the effect on TCC of changes. Owners should be advised to contact the IRC Rating Authority through their Rule Authority.

In the particular case of measurement for Endorsement, owners and/or measurers should contact their local IRC Rule Authority first and direct the owner to an official measurer.

A specific point to note: Official measurers should **NEVER** interpret IRC rules. If an owner asks you to interpret, or you are in doubt, contact the IRC Rating Authority through your local Rule Authority. Measurers do not have the authority to interpret IRC Rules. That right lies solely with the IRC Rating Authority.

## 3. RULES AND DOCUMENTATION

Measurers will need to have the following documentation available to them:

Document	Source
IRC Measurement Documentation	<a href="http://www.ircrating.org/technical-a-certification/measurement">http://www.ircrating.org/technical-a-certification/measurement</a>
IRC Rules	<a href="http://www.ircrating.org/technical-a-certification/rule-a-definitions">http://www.ircrating.org/technical-a-certification/rule-a-definitions</a>
World Sailing ERS	<a href="https://www.sailing.org/inside-world-sailing/rules-regulations/equipment-rules-of-sailing/">https://www.sailing.org/inside-world-sailing/rules-regulations/equipment-rules-of-sailing/</a>

The IRC Rules incorporate the ERS and we use the convention that a word printed in IRC Rules in **bold** is being used in the ERS defined sense. This has then been extended such that a word printed underlined is being used in its IRC defined sense. IRC definitions are contained within IRC Rules as Appendix A. ERS definitions are not repeated in IRC Rules. Apart from direct quotes from IRC Rules or definitions, this convention has generally NOT been followed in this manual



## 4. EQUIPMENT

With the exception of weighing, complicated measuring equipment is not needed. If full measurement is the target, the following will be required:

### Essential:

Steel tape measures:	5m and 30m (50 metres for large boats), EC Class II accuracy
Wooden (floating!) rulers:	1m and single hinge 2m
Spirit level with 45° bevel:	0.5m (minimum)
2 plumb bobs	
Sundry string	
Basic tools:	pliers, screwdriver, PVC tape, masking tape

### Desirable:

3, 8 and/or 10m steel tape measure	2m multiple hinge wooden ruler, EC Class II accuracy
2 more plumb bobs	0.15m - 0.20m spirit level
Callipers	Optical or laser level

## 5. ACCURACY

IRC Rule 8.10 states

### 8.10 Rated Dimensions

- 8.10.1 Values stated on certificates for **LH, Hull Beam, Bulb Weight, Draft, x, P, E, J, FL, MUW, MTW, MHW, HLU<sub>max</sub>, HSA, FSA, PY, EY, LLY, LPY, Cutter Rig HLU<sub>max</sub>, SPA, STL, SPL, STL<sub>FHmax</sub>** are maximum values.
- 8.10.2 Values stated on certificates for **Boat Weight, BO, h, SO, y, and Internal Ballast** are minimum values.
- 8.10.3 If during **Equipment Inspection** by an **Equipment Inspector**, or during measurement carried out under Rules 10.2 or 13.6, any rated dimension is found to exceed a maximum value or to be less than a minimum value, then the **boat** is not in compliance with her certificate.
- 8.10.4 Attention is drawn to Rule 13 and to RRS 78, *Compliance with Class Rules; Certificates*.

This defines clearly when a boat is not in compliance with her certificate. It is relevant to a measurer acting as an Equipment Inspector at an event.

The introduction to IRC Rule 9 states:

### 9 Rating review

Rule 9 does not apply to **Equipment Inspection** at an event.

Question: Who applies IRC Rule 9?

Answer: The Rating Authority.

Question: Who applies IRC Rule 10 (which refers to IRC Rule 9)?

Answer: The Protest Committee and the Rating Authority. A measurer never has any decision to take in the application of IRC Rules 9 or 10.

Attempts have been made to take the protest limits of IRC Rule 9.8 as measurement 'tolerances'. In other words, measured linear dimensions are adjusted by the protest limits. This is NOT the purpose



of IRC Rule 9.8. Measurers shall report the actual measurements found which will be used for rating the boat.

It should also be noted that in the case of a compound multipart measurement, (LWP for example), the final accuracy is dependent on the accuracy of the component parts. To demonstrate: if LH, BO and SO all have errors of 50mm, then LWP could be in error by as much as 150mm. Unlikely perhaps, but to be borne in mind by the measurer.

This issue is relevant also to the equipment used. When weighing for example, ensure that the accuracy of the equipment is sufficient. The IRC Rating Authority uses load cells with a quoted accuracy of  $\pm 0.2\%$  of maximum capacity, ie, for a 10 tonne cell  $\pm 20$  kg, or for a 20 tonne cell,  $\pm 40$  kg. As a rule of thumb, a load cell should not be used to weigh a boat with a weight of less than a minimum of 15% of the cell's capacity. Inevitably, this 'rule' may be breached on rare occasions.

## 6. TECHNIQUES

Please note the following pointers to good measuring practice:

- Ensure horizontal measurements are truly horizontal. For instance, when measuring from a reference point to a plumb line, hold the end of the tape on the reference point and arc the tape behind the plumb line looking for the minimum figure.
- Ensure vertical measurements are actually vertical. For instance, when measuring draft ashore, allow the tape to hang freely. If it does not hang above your lower reference point, move so that it does.
- When measuring to a plumb line, hold the tape behind the plumb line. The required measurement is then clearly marked by the tape.
- Never measure between two plumb lines, always between each plumb line and a fixed reference point.
- Be very aware of the environment, particularly the effect of wind and/or current on plumb lines and free hanging tapes. On a windy day, use a weight to steady the tape.
- Never attempt to identify the waterline (eg for draft or overhangs) by reference to for example discoloured anti-fouling. This is firstly inaccurate in itself, and secondly may be misleading if the boat was not floating in the correct trim.
- Whenever possible repeat a measurement, including any setting up. This practice is a good example of not only doing a good job, but being seen to do so by the owner. Their confidence will be affected not by your measurement but by the presentation of your measurement.

## 7. PREVIOUS MEASUREMENTS

Many boats will have had either IMS (ORCi), ORC Club, or certificates under other local measurement rules in the past. With care, some of the figures on the most up to date certificate may be directly useable. Others will require checking. In general, hull measurements will not have changed, unless the boat has been modified. Others, such as rig and sail measurements will often need physically checking. Care should be taken to ensure that the data on a boat's certificate under another rule is real data as opposed to 'class standard' data which may be the case under for instance ORC Club and some local rules. Additionally, IRC definitions are in many cases not the same as definitions under other rules. Great care should be exercised in this respect. The following may be used as a guide:



	IRC	IMS/ORCi	Comment
Values likely to be unchanged:	LH	LOA	
	Hull Beam	BMax	Unlikely to change, but has been known.
	Engine weight	EW	
	J	J	

Values which may have changed:	STL	SPL	Note that IRC defines STL differently
	P	P	
	E	E	
	Draft	D	May have changed, either as result of keel modifications or re-ballasting.
	Sail data	Various	Note variation in definitions of dimensions.

## 8. WEIGHING

### 8.1 Weighing Equipment

The weight of boats causes possibly the most dispute of any measurement; while an apparently simple procedure, it occasionally results in wildly anomalous figures. In most cases, this can be ascribed to inadequate weighing equipment.

When weighing for Endorsement purposes, measurers should refuse to use a load cell that has not been cleared by the IRC Rating Authority or the local IRC Rule Authority. An officially owned load cell is to be preferred whenever possible. Experience over the years has shown that weighings using officially owned or sanctioned equipment are close to 100% reliable. When other load cells are used, of the order of 50% of weighings are subsequently proved to be inaccurate.

The shackles for the load cells have to be carefully sized, not only for strength, but for match to the holes in the load cell. A minimum freedom of movement has to be allowed, otherwise any torsion or twist when lifting will be directly transmitted into the load cell, giving a potentially erroneous answer. If too much freedom of movement is given, the measurement can also be wrong.

The load cells can be susceptible to temperature changes, care should be taken to avoid large temperature changes prior to weighing i.e. storing in a warm office prior to weighing on a cold day or a cold (air conditioned) areas before weighing in hot climates. When arriving on site open up the load cell and set up to allow as much acclimatisation as possible. Load cell battery level is also important. If in doubt, change or charge the batteries.

### 8.2 Weighing Condition

There are a number of traps the measurer can fall into when setting up the boat weighing condition. It is absolutely essential that the boat is EMPTY (see measurement condition in IRC rule 17). The measurer must be pedantic, inspecting every locker, lifting every board, and insisting on the removal of EVERYTHING, down to the toilet rolls.

Among things to watch for are:

- Bilges full of water.
- Mainsail on the boom.
- Anchors 'forgotten' under bunks.
- Water fuel and holding tanks. Watch for second (and third and fourth....!) water tanks.
- Chart tables full of charts and other rubbish.
- Portable electronic equipment (laptop computers etc.)
- Safety gear: horseshoe rings and Dan buoys on the transom.
- Gas bottles (and spares!).
- Fire extinguishers.
- Are removable cockpit boxes on board?
- Fenders and mooring lines as the boat is lifted.



- Running rigging shall be slack.

Do not treat the above list as exhaustive. Vigilance is the only answer.

It should be noted in the weighing report cushions that were on board or not on board and if removable cockpit boxes were on board or not. The number of batteries on board should also be noted.

Water and holding tanks should be pumped dry and water ballast tanks shall also be empty. Fuel is more difficult and it is acceptable to deduct a known weight of fuel from the gross weight. If doing the latter, two means of estimating quantity should be sought. For instance, a fuel gauge, and a measurement of tank volume together with either dipping the tank or a sight glass. The fuel gauge alone should be a last resort. Diesel has a specific gravity of 0.85, i.e. 1 litre weighs 0.85 kg.

The only loose items aboard should now be fitted (but not necessarily fixed) bunk cushions, loose bunk boards, floor boards and washboards, and spinnaker pole(s). Make a note of the number of loose cushions for our records. Note: also the number, identification if possible, and size of batteries (if there are an unusually large number of batteries, check that they are actually connected), and the quantity of internal ballast. In the case of production boats any deviations from standard, e.g. addition/removal of furniture such as doors and tables should also be noted.

### **8.3 Weighing Method**

Having emptied the boat, the weight of lifting gear below the load cell (i.e. spreader bars, straps, shackles, etc.) must be found for deduction from the gross weight. Unless using an internal centre lift point, if the boat is to be lifted from the water, the slings should first be immersed. On some load cells, this weight can be zeroed out. It is left to the measurer's discretion whether they do this or notes the reading for later deduction.

When a boat is weighed, the overhangs should always be measured simultaneously. A weighing report should be produced defining what was on board and what was not, quantity of fuel and water, and overhang measurements.

The IRC Rating Authority's strongly preferred method of weighing is hanging the boat from a single point beneath a load cell. This may be either using a boat's built in lifting point or straps around the hull with or without a lifting frame/spreader bars. Provided that the weight of whatever lifting gear is used is tared off, it doesn't matter which. Experience over the years has shown that single point lifting to be by far the most reliable and repeatable method of weighing boats.

An alternative acceptable method is the use of 3 or 4 compression load cells to weigh the gross weight of the boat in a cradle. By then deducting the weight of the cradle, boat weight can be found. This method can produce good results, but is more susceptible to error by way of missing straps, and other equipment. It is also a composite measurement, with all the inherent possibilities for error. Good measurement practice is essential. Please see Appendix 1 and discuss the method intended with the local IRC Rule Authority before going ahead.

The boat should now be weighed twice, with all weight removed from the load cell between weighings. If any significant (+/-10kg) difference is seen, STOP AND FIND THE PROBLEM. Re-weigh the straps etc. to check finally that nothing has shifted. Again if any significant difference is seen STOP AND FIND THE PROBLEM.

Attention is drawn to the table in paragraph 4 of Appendix 3, IRC Endorsement. This clearly defines the various acceptable methods of establishing the weight of a boat and those methods which are not acceptable.

Be rigorous in recording everything, and input all weights, notes and comments. Please do NOT 'adjust' the figures.

So what goes wrong? Obviously, equipment still aboard will not help! There are however also many more subtle things. Wind and rain can have noticeable effects. Directly, wet decks and topsides can hold significant quantities of water. Wind will also always increase the figure read. Ideally, weighing



should be carried out in light winds, preferably 10 knots or less and dry weather. It is recognised however that this will often not be practical. With care, satisfactory results can be achieved in stronger winds. It is also sometimes possible to find a sheltered location. It is therefore left entirely to the discretion of measurers when to abandon a weighing because of conditions. Measurers must always report actual conditions to the IRC Rating Authority.

When noting the weight of strops etc, read the sign (+ or -) on the display. Negative values are quite possible if the display has not been zeroed before use.

Please also note that the IRC Certificate now also includes Bulb Weight for boats with keel types 10, 11 and 12. How to establish this, if needed is detailed in Appendix 9.

#### **8.4 Alternative Weighing Methods**

Historically, weighing on compression load cells was generally acceptable for an endorsed certificate. Now, for the purposes of endorsement, this method has been moved to 'at the discretion of a Rule Authority'. This change was made firstly as a result of concerns over general reliability and secondly because the local IRC Rule Authority is the only body in a position to properly review the proposed process in each case. See Appendix 1 for more information.

Currently weighing a boat hung in a travel lift rolled onto compression load cells is **NOT** an approved method of weighing.

Recording the load in each sling of a travel lift by either load cell or the travel lift's in-built equipment is **NOT** acceptable. The latter particularly has been shown to be capable of errors of up to 50%! The former is erroneous to the extent that the slings are not vertical, either athwartships or fore and aft. Simple geometry shows that very small errors in sling angles rapidly combine to produce gross errors.

For very large boats, generally longer than 30.5m or weight in excess of 20 tonnes, the Rating Authority may approve calculation of weight from flotation followed by calculation and declaration of weight by the Rating Authority. See Appendix 2 for more information. The Rating Authority may delegate this task to the designer. If this approach is to be taken, the IRC Rating Authority must first be contacted to discuss the proposed method.

## **9. HULL**

### **9.1 LH – Hull Length**

This is best done ashore. Owners should be informed in advance that the boat has to be set up level with the waterplane in Measurement Condition, which is a task that has to be performed before the measurer arrives. Hang plumb bobs on the centreline over the bow and stern. Measure from a convenient point on the keel or underbody to each plumb line and total for LH.

**DO NOT:** Include pulpits, pushpits, stemhead fittings, runner/backstay tangs, bowsprits, etc.

**DO NOT:** Measure LH with the boat out of level fore and aft. You will get the wrong answer. On occasion, measurers may find that a boat has been deliberately levelled bow up to minimise measured LH. Measurers are quite within their rights to require that the boat be re-levelled.

If necessary, LH can be measured afloat by dividing the boat into convenient sections, measuring each and totalling. Eg: (Stem to mast) + (mast) + (mast to forward face of cockpit), etc. If doing this, be careful and check that reference vertical surfaces are actually vertical.

### **9.2 Hull Beam**

Inspect for maximum hull beam station by sighting from off the boat. It is very desirable to do this from both ahead and astern of the boat if possible. It is easy to be fooled by the shape of the boat! Maximum beam is nearly always further aft than you think. If in doubt, check several stations to find a maximum value.

Having found the right station:





If afloat: Using a level held vertically at the point of maximum hull beam (ignoring rubbing strakes) measure inboard to a convenient point on the deck of the boat. Repeat from the other side. This method is not recommended as it is far less precise than ashore.

If ashore: Hang plumb bobs at the required station and measure in from each to a reference point on the hull or keel. Again, NEVER measure directly between two plumb lines.

### **9.3 Draft**

The boat will need to be seen by the measurer both ashore and afloat. It doesn't matter which is first. It is better to start ashore to determine the lowest point of the keel. As with overhangs, draft is measured in IRC measurement condition (see IRC Rule 17).

Ashore: Ensuring first that the boat is in level trim, establish a convenient reference point on each side of the boat above the waterline in way of the section at maximum keel depth. Using a spirit level, project horizontally from the underside of the keel outboard to vertically below the reference point each side. Measure vertically down from each reference point. Alternatively, if available, a surveyor's level may be used.

If measuring a drop keel boat, measurements will be needed with the keel fully up and fully down.

Afloat: Ensure first that the boat is in measurement condition (IRC rule 17), that everybody is off the boat(!), and that the boat is in level trim both fore and aft and athwartships. If doing the afloat measurement first, mark the reference points on the hull as above.

Using a wooden ruler, measure vertically downwards from the reference point each side to the water surface. By subtraction from the ashore figures, and then averaging the results, draft is found.

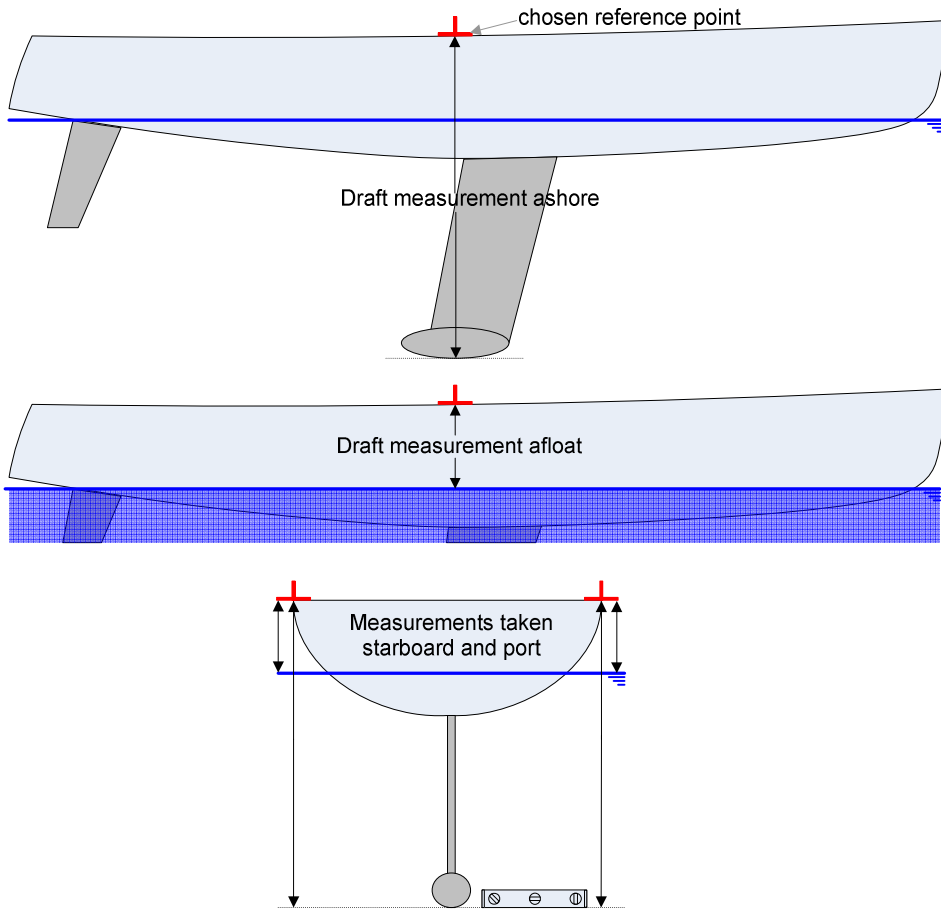

$$\text{Draft} = \text{Draft measurement ashore} - \text{Draft measurement afloat}$$



#### **9.4 Overhangs**

Please refer to the attached diagrams before taking any measurements. Before an IRC certificate can be issued, BO, SO, y, x, and h are required for EVERY BOAT.

The boat should first be inspected to ensure she is, as required by IRC rule 18, in measurement condition (rule 17).

Bow overhang is usually straightforward. Stern overhang can be difficult. These measurements can only sensibly be taken in still water. Any current will offset the plumb line positions; even small waves can make an accurate stern overhang measurement very difficult.

Note that on boats with skegs, stern overhang is measured to the intersection of the actual hull (the canoe body) with the water, ignoring the skeg.

If the upper end of the rudder is above the waterline, it is preferable to measure SO on both sides.

Hang a plumb line over the bow and stern, ensuring that they are on the centreline and do not include any hull fittings.

**Bow (BO):** Using a floating ruler, position one end of the ruler against the bow at the waterline. Pivot the ruler about this point towards the plumb line. Repeat as many times as is necessary to achieve a consistent result.

**Stern (SO):** Measurement can be difficult, particularly with modern designs with transoms low to the water. A dinghy or float is essential with an assistant to hold this in position. As with the bow, position the end of a floating ruler against the required measurement point and pivot the ruler about this point towards the plumb line. Repeat as many times as necessary to achieve a consistent result.

**y:** In all cases, the dimension 'y' should also be supplied. Measurement is straightforward.

**x and h:** If the boat has a flying bow, measure also x and h. The diagrams define the exact measurement points. x can be awkward to measure. h is straightforward once the measurement point has been established. If there is no flying bow, please say so and input 0 figures for x and h

As an alternative to direct measurement of BO, x and SO, if the bow and stern profiles are known (or have been measured ashore), then measurements of y and h (the easier and more accurate measurements to take directly) can be used to find BO, x and SO by either calculation or graphical methods.

**BOW OVERHANGS**

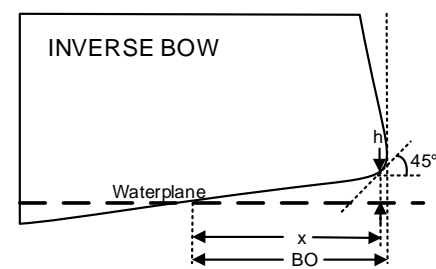
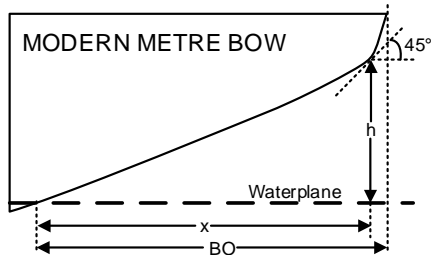
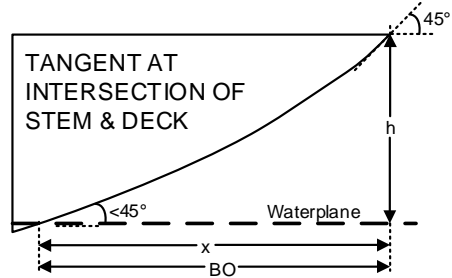
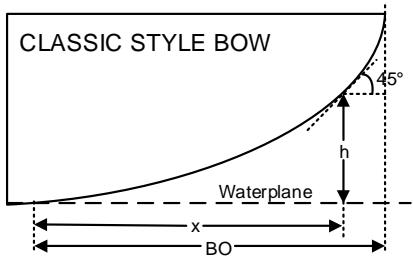
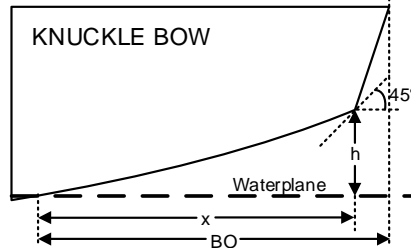
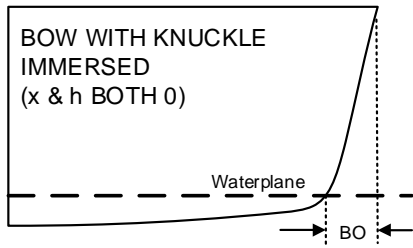

**STERN OVERHANGS**

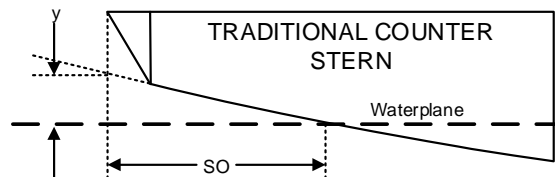
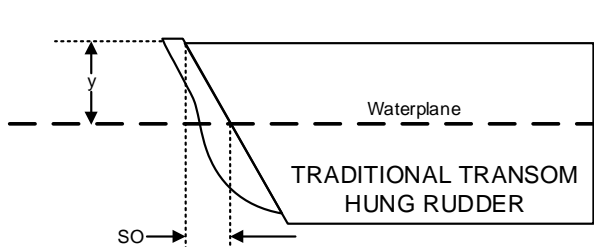
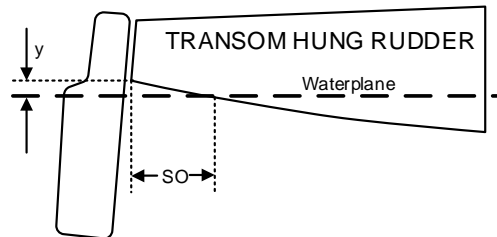
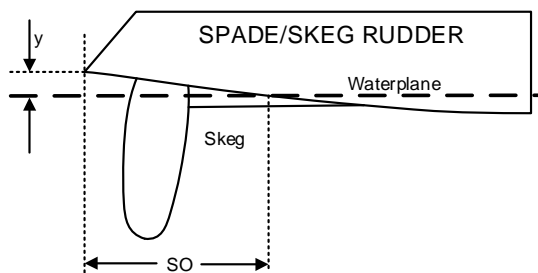

## 10. SPARS AND RIG

### 10.1 P, E, J and FL

Spar and rig measurements are straightforward. P and E are exactly as most other rules, with the exception that if there are no measurement bands, P is measured from the top surface of the boom or boom track to the halyard shackle pin when the halyard is fully hoisted, and E is measured from the aft face of the mast to the extremity of the boom.

RIG MEASUREMENT POINTS

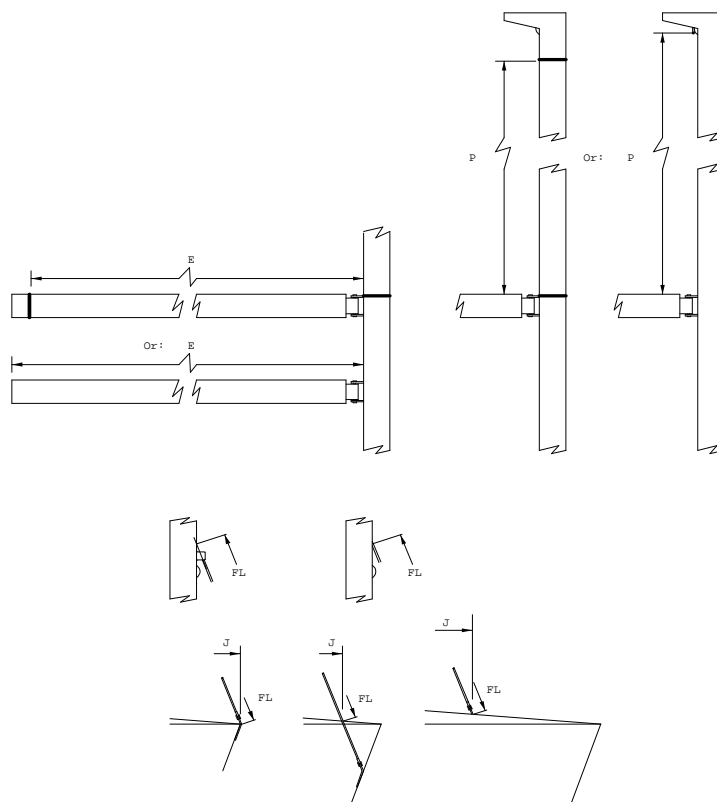

Hoisting a tape on the main halyard and judging its position by eye from on deck is not an accurate method. For Endorsed certificates, this is NOT acceptable. If the rig is up, sending a man aloft with the tape is the only method.

The IRC definition of Forestay and the definitions of J and FL amended to read:

- Forestay**    *The ERS definition of **forestay** shall not apply. Forestay is defined as: Permanently attached **rigging** providing forward support for a mast **spar**.*
- FL**            *The forestay length measured from the forward end of J to the forestay rigging point. (Note: The forestay length is a maximum value, conformation should be sought from the owner/representative to confirm the forestay is in its maximum sailing length setting)*
- J**              *The longitudinal distance between the intersection of the fore side of the mast **spar**, extended as necessary, and the deck including any superstructure; and the intersection of the centreline of the forestay, extended as necessary, and the deck, or bowsprit **spar**.*

The substantive effect of these changes is that FL and J are always measured to the permanent forestay.



In addition, Rules 21.3.3 and the definitions of Headsail and LP have been amended:

21.3.3 *RRS 55.3 is amended to the extent that a spinnaker, headsail or flying headsail may be tacked to a **bowsprit**.*

*Headsail ERS G.1.3(d) shall not apply. Any **sail** tacked down forward of the foremost **mast** which does not meet the definition of a spinnaker or flying headsail. A headsail may be hoisted from above the forestay rigging point.*

These changes clarify that a headsail may be hoisted and tacked from outside the foretriangle.

J is therefore measured in exactly the same manner as for other common rating rules. Note that J is measured horizontally. A spirit level to project upwards from the forward measurement point to the height of the mast at deck level is nearly always necessary.

FL can be a little more complex depending on the detail of the forestay attachment. What is required is the point where the centreline of the forestay intersects the front wall of the mast, or would if extended. The only exception to this is a masthead rig where the upper limit is the top surface of the mast. The attached diagrams show the various possibilities. Again someone will need to go up the mast.

At the bottom of FL, the measurement point is as for J. The diagrams attached show all of the above.

Measurers should be clear that we want the real forestay, not a thin cable that is declared as permanent, but which clearly achieves nothing when it comes to holding the rig up.

In 2016 definitions of HLU, HLP, HHW, HTW & HUW specific for Cutter Rigs were added to the IRC Measurement Definitions including the definition of a Cutter Rig.

*Cutter Rig A cutter rigged boat is any **boat** that sets more than one headsail when on a beat to windward while racing. These values will be used in place of standard headsail dimensions where relevant in IRC Rules for a cutter rigged boat.*

The term beat to windward is defined in ISAF Case 132

<https://ircrating.org/latest-tech-news/478-beat-to-windward>

P and FL may also be measured with the rig down. In both cases however, measurement will be to a reference mark on the mast/forestay for later correction to the actual lower limit of P/FL.

The definition of E has been amended by the addition of:

*Fittings, local curvature, local cutaway and any increase in the fore/aft dimension of a sail track and/or sail track support, shall be ignored.*

This closes a loophole applicable to large boats with in-boom mainsail furling but which could also have been exploited by smaller boats.

## **10.2 STL**

The definition of STL is as follows:

STL The greatest horizontal distance from the forward face of the **mast spar**, ignoring any **fittings** and tracks, measured on or near the centreline of the **boat**, to any of the following:

- the extremity of the **bowsprit**, ignoring any **outer limit marks**;
- the spinnaker tack point on deck projected vertically as necessary;
- if a headsail or a flying headsail may be tacked forward of the forestay, the headsail or flying headsail tack point on deck projected vertically as necessary or to the extremity of the **bowsprit** ignoring any **outer limit marks**.

It is important to note that the measurement is taken to the extremity of the **bowsprit** and not to the block/ferrules which the tack line passes through on a bowsprit.

### Bowsprit Extremity

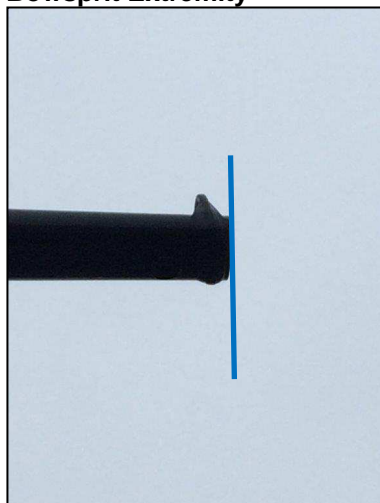

It is important to note that the measurement is taken to the extremity of the **spinnaker pole**, **whisker pole** or **bowsprit** and not to the bearing point of a spinnaker pole or the block/ferrules which the tack line passes through on a bowsprit.

If the tack point is on the deck the measurement is taken to the tack point on deck projected vertically as necessary. The longitudinal extend of the tack point is considered to be the centre of the fixed attachment point.

### Tack Point on Deck

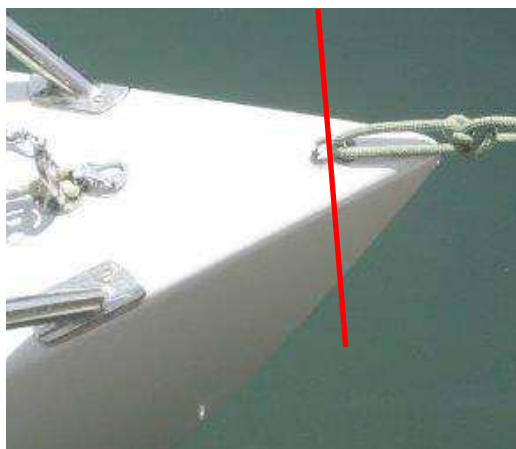

### 10.3 SPL

SPL The greatest horizontal distance from the forward face of the **mast spar**, ignoring any **fittings** and tracks, measured on or near the centreline of the **boat**, to the extremity of the **spinnaker pole**.

It is important to note that the measurement is taken to the extremity of the **spinnaker pole** and not to the bearing point of a spinnaker pole.

#### Spinnaker Pole Extremity



It is also important to note that as defined, the spinnaker pole shall be in a horizontal position when measuring SPL, which does not mean that the spinnaker pole is at right angle to the mast. The horizontality shall be check with a spirit level placed on the pole.

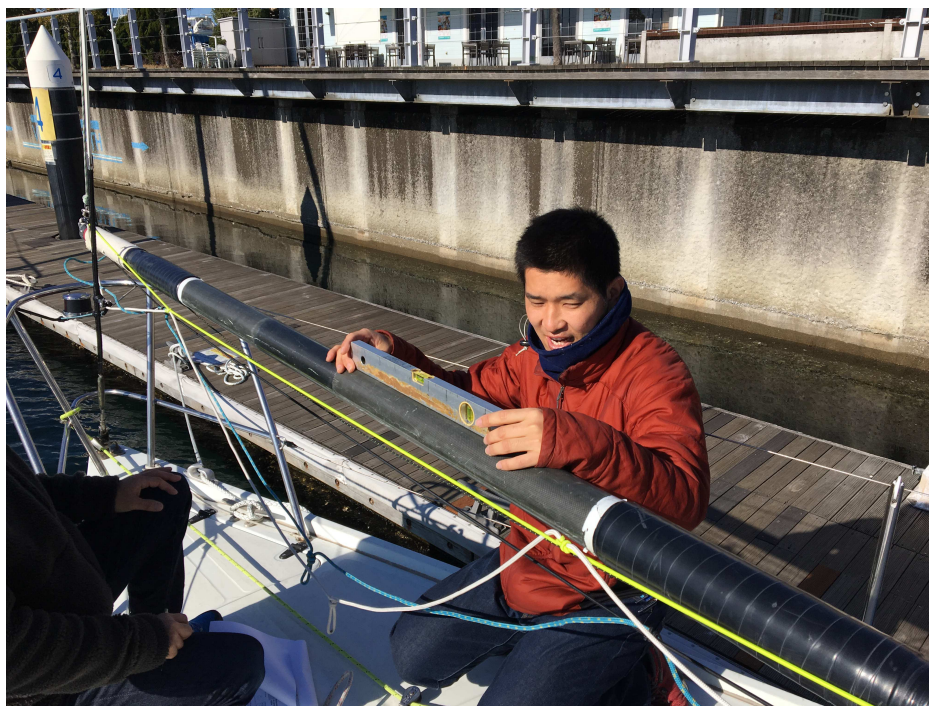





#### **10.4 Aft Rigging**

Confusion exists in the difference between **Backstay**, **Running Backstay** and **Checkstay**, especially in defining the difference between a Backstay & Running Backstay when the cable passes through the spar below the Upper Point but attaches to a pin above the Upper Point. To remove this confusion we no longer differentiate but count the number of attachments or pairs of attachments.

Aft rigging: The total number of **stays** and/or sets of **stays** connected to the mast **spar** above the top of the boom set horizontal providing aft support and/or control.

(a) Any pairs of **stays** attached to the mast **spar** at the same position port and starboard on the mast **spar** shall count as one set of **stays**. Eg, whether there be a single standing **backstay** or twin **running backstays** these are counted as one set of **stays**.

(b) Any deflectors or adjusters attached between the top most **stay** and the mast **spar** shall also be counted. Any deflectors or adjusters attached between any other **stay** and the mast **spar** with separation from the attachment point of the primary **stay** of 10% of P or greater shall also be considered as a separate **stay** for these purposes.

Note – The exemption for deflectors within 10% does not apply to deflectors from the top most stay.

## Aft Rigging

ONE STAY/  
SET OF STAYS

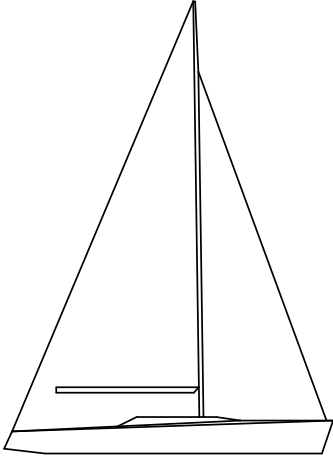

ONE STAY/  
SET OF STAYS

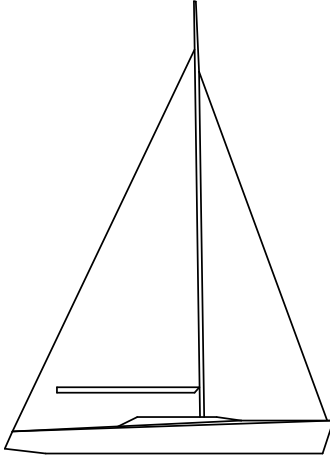

TWO STAYS/  
SETS OF STAYS

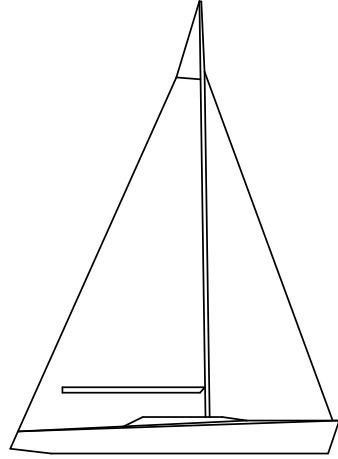

TWO STAYS/  
SETS OF STAYS

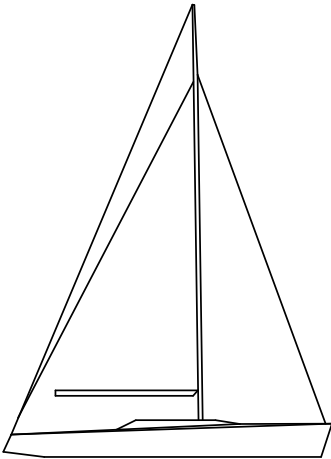

TWO STAYS/  
SETS OF STAYS

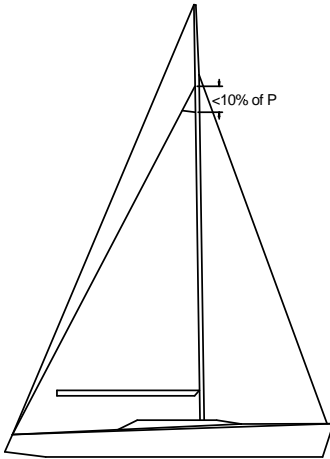

THREE STAYS/  
SETS OF STAYS

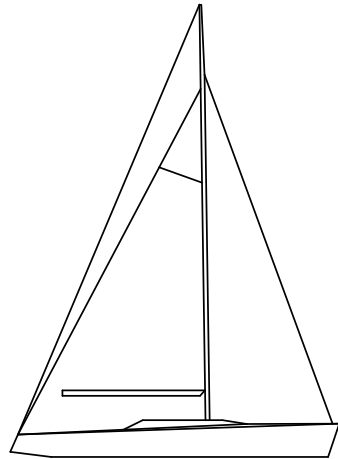

THREE STAYS/  
SETS OF STAYS

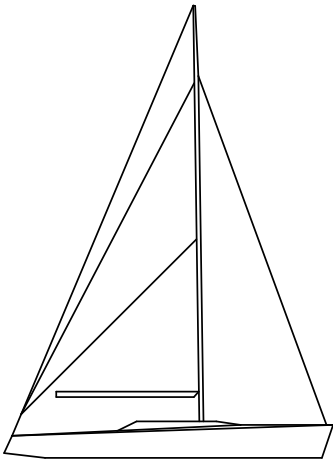

THREE STAYS/  
SETS OF STAYS

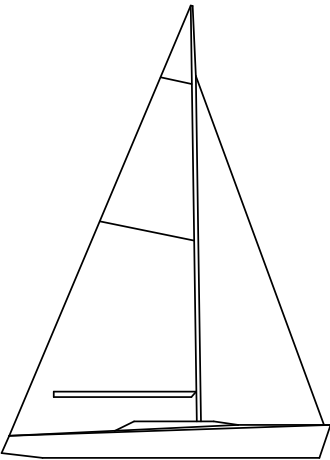

THREE STAYS/  
SETS OF STAYS

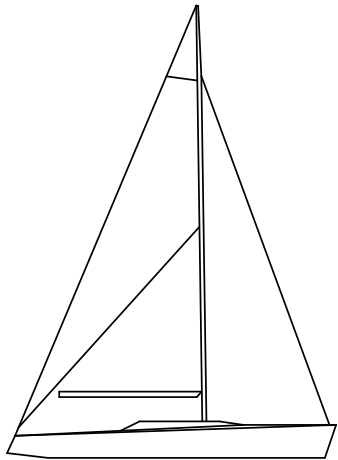

## 11. SAILS

ERS H.5.1 specifies the condition of the sail for measurement as dry, in addition prior to measuring any consideration should be given to the environmental conditions in which the measurement is being conducted. Extremes of temperature either ambient or direct sunlight in addition to moisture can cause variances in measurements.

It is preferable that sail measurement is carried out under cover to minimise the impact of any variance through environmental factors.

The complete incorporation of ERS makes no changes to the measurement of sails under IRC which was already carried out in accordance with ERS. However, the nomenclature has been updated in agreement with the ORC and as approved by World Sailing as an appendix to ERS as outlined in the table below.

IRC Rules do not differentiate between spinnaker types. All spinnakers are measured in the same way, irrespective of shape. Be aware that sail cloth can shrink/grow with time, use and sometimes moisture. The fact therefore that a sail has a measurement stamp on it does not guarantee that it measures. For Equipment Inspection at events, the only sure way is actually to measure the sail. The historic rules relating to sailcloth have now effectively disappeared. While IRC Rule, 21.4 refers to 'exotic materials' in sailcloth, the current exotic list is none.

IRC Rule 21.1.5 (h) prohibits sails with detachable pieces. IRC does not include any rules regarding sail reinforcement.

IRC sail measurement is very straightforward. Mainsails require measurement of widths, 5 measurements for headsails, 4 for spinnakers and 7 measurements for flying headsails (5 headsail measurements and in addition foot length and mid-width measured as a spinnaker) as follows:

Sail	Measurement	Dimension
Mainsails:	Half Width Three Quarter Width Upper (seven eighth) Width	MHW MTW MUW
Headsails:	Luff length Luff Perpendicular Half Width Three-Quarter Width Upper (seven eighth) Width	HLU HLP HHW HTW HUW
Spinnakers:	Luff length Leech Length Foot Length Mid Width	SLU SLE SFL SHW
Flying Headsails: measured as a headsail	Luff length Luff Perpendicular Half Width Three-Quarter Width Upper (seven eighth) Width	FLU FLP FHW FTW FUW
measured as a spinnaker	Foot Length Mid Width	FSFL FSHW

Attention is drawn to the quick reference guides to sail measurement included as Appendices to this manual.

For all measurements, light tension should be applied to the cloth, sufficient to remove wrinkles. Measurers should however be aware of the potential shortfall in luff length caused by not stretching the boltrope when measuring HLU, and if uncertain should err on the side of excessive tension.



Measurers should also be aware that sailmakers on occasion (and particularly for smaller boats with hanks as opposed to luff grooves) sometimes fit pre-stretched headsail bolt ropes which when relaxed are significantly shorter than the luff length of the sail itself. In this context, light tension may be taken to mean firmly pulled by hand.

### 11.1 Spinnaker

IRC definitions define a spinnaker as

Spinnaker ERS G.1.3(f) shall not apply. A spinnaker is defined as a **sail** set forward of the foremost **mast** with **half width** (measured as a spinnaker) equal to or greater than 75% of **foot length** and without battens. A spinnaker may be set reefed by any means while *racing* under IRC provided that when measured in any reefed condition it continues to satisfy the IRC definition of a spinnaker.

Thus, if a sail satisfies the definition of a spinnaker (ie half width is equal to or greater than 75% of foot), then that is what it is: a spinnaker. Any other sail is a headsail. 'Code zeros' are nearly always intended by the sailmaker to be spinnakers. Measurers should however beware. If however a sail has battens, defined in IRC as *Any material added to the sail, as either a removable element, permanent stiffening, or other contrivance, the purpose of which is to support and/or stiffen the sail*, then it is a headsail rather than a spinnaker, irrespective of what the dimensions are.

For spinnakers, what is required are the dimensions of the largest area sail calculated from:

$$SPA = ((SLU + SLE)/2) * ((SFL + (4 * SHW))/5) * 0.83$$

While SPA is all that is required for rating the boat, measurers are asked to submit actual sail dimensions to minimise the likelihood of error.

### 11.2 Flying Headsail

A flying headsail is defined as follows:

Flying Headsail ERS G.1.3(d) shall not apply. A **sail set flying** tacked down forward of the forestay that does not meet the definition of spinnaker and without battens and with a **half width** (measured as a spinnaker) equal to or greater than 62.5% of **foot length**. A flying headsail shall be tacked down no greater than STLFHmax and approximately on the **boat's** centreline, except when it is tacked on a declared articulating **bowsprit**. A flying headsail may be entirely furled but shall not be set reefed while *racing*.

So a flying headsail concept is to allow an offwind sail that measures as a headsail, similar to the 'Code zero' concept. It is effectively a headsail without battens that is set flying with a mid-width to foot length ratio greater than or equal to 62.5% and less than 75%. The area is calculated the same as headsail and thus the measurements are same. But to establish if it meets the mid-width to foot length ratio limits, these must also be measured as if the sail is a spinnaker.

### 11.3 Headsail

For a headsail the required dimensions are HLU, HLP, HHW, HTW and HUW of the largest area headsail. In addition, the longest luff length (HLUmax) of any headsail carried is also required. In parallel the calculation of HSA, was amended to:

$$HSA = 0.0625 * HLU * (4 * HLP + 6 * HHW + 3 * HTW + 2 * HUW + 0.09)$$

The IRC definition of HUW defines **upper leech point** as the point on the **leech** equidistant from the **head point** and the **three-quarter leech point**. This point is simply found by folding the head of the sail to the **three-quarter leech point**.

Historically, HHW and HTW were never taken as less than 50% & 25% of HLP respectively for the purpose of the calculation. With effect from 2012, these minima have been removed. Measurers should therefore measure HHW and HTW for all headsails so that boats get the rating benefit of any general leech hollow. Measurers should however be aware that it is very common for the leech of a sail to be hollow between battens. Measurers should check all sails and bridge any hollows between battens found as described by ERS (see ERS G.2.4 and ERS H.5.2).



The actual dimensions of the largest area headsail, (not just HSA) are needed.

The IRC rule 21.7.2 now includes: *which may be used while racing*. This then formally covers the situation of a boat rated with a single roller furling headsail carrying other sails on board as permitted by Rule 21.8.4 without affecting her TCC.

The IRC definition of Foot Offset is as follows:

Foot Offset            The maximum offset between the edge of a **headsail foot** and a straight line between **tack point** and **clew point**.

This has been added to close a loophole and is linked to IRC Rule 21.7.1:

If foot offset is greater than 7.5% of HLP, then foot offset shall be declared and foot offset shall be added to HLU in the calculation of HSA.

It is considered unlikely that many, if any, sails will have Foot Offset in excess of 7.5% of HLP. Measurers are asked however to check and report any excessive values found.

We have also seen a recent trend towards careful placement of headsail battens to minimise 'hollows' as defined by ERS. If in doubt, please refer to ERS and/or consult your local IRC Rule Authority.

IRC Rule 21.8 gives a rating credit to boats rated for a single roller furling headsail. To be eligible, (with the exception of boats with LH greater than 30.5m and IRC DLR greater than 60) rated HLP must be greater than  $1.3 * J$ . The Rating Authority will pick up qualification in this regard. More importantly from a measurer's point of view is that, while other sails may be carried aboard, only storm jibs and, when declared, heavy weather jibs may be used while racing. The definitions of storm and heavy weather jibs are as defined by IRC definitions:

*Storm Jib*    A headsail of area not greater than 5% **foretriangle height squared**, **luff length** not greater than 65% of **foretriangle height**, and not containing aromatic polyamides, carbon or similar fibres.

*HWJ*            Heavy weather jib. A headsail of area not greater than 13.5% **foretriangle height squared**, and without reef points.

Note that a No.3 headsail is NOT a Heavy Weather Jib. In relevant cases, IRC certificates show the maximum permitted heavy weather jib area.

**SAIL MEASUREMENT POINTS**

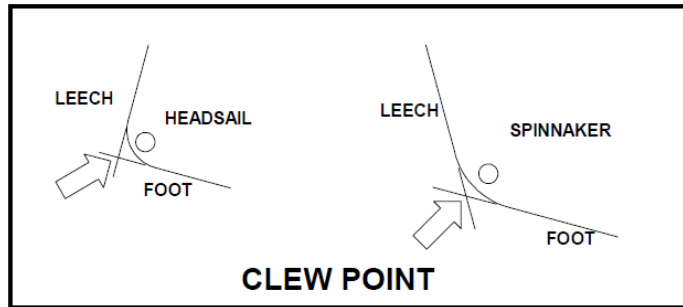
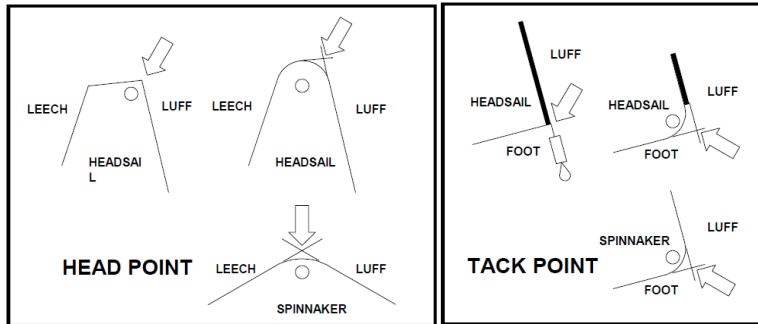
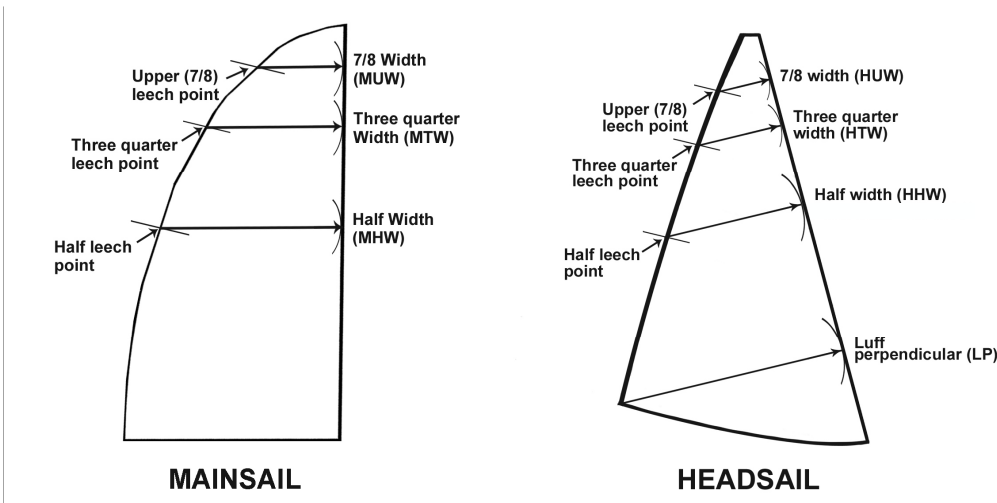

## 12. PHOTOGRAPHY FOR RATINGS

When measuring one-off boats, or endorsement generally, measurers are asked whenever possible to take photographs (keel, rudder, interior, etc) for inclusion in the boat's file.

### KEEL/RUDDER:



Although this photo shows the keel type, it is taken at an angle and is obstructed



This is better!



If the keel is 'low cg' (as shown above), a fore/aft view is extremely helpful



This side profile photo shows the rudder depth and style



This clearly shows rudder and propeller



Skeg clearly visible as is propeller

**RIG:**



A photo of the rig showing the number of spreaders, spreader sweep and other rigging, e.g. runners/checkstays is useful

**INTERIOR:**



Photos facing aft are helpful. In these two you can clearly see the aft accommodation and heads



Photos showing the main cabin and forward



Clear photos of the Chart Table and Galley





### 13. OTHER ISSUES

Measurers should be aware of other IRC rules issues and are asked to report as much additional detail as possible for recording in a boat's file. For instance:

- Which version of the design? Mk I? MK II? Deep draft? Shallow draft? Etc.
- Has furniture been removed from below and not reported in contravention of IRC rule 22.1?
- Are removable cockpit boxes on board?
- Are the correct number of spreaders and Aft Rigging declared?
- Is the mast aluminium or carbon?
- Is the standing rigging wire, rod, or composite materials. Specifically, what is the forestay material ?
- Quantity (if any) of internal ballast. Has ballast been added or removed?
- If originally an IOR rated boat, have the bumps and creases been faired out?
- No. of spinnakers carried.
- Does the boat use stored power? See IRC rule 15.
- Does the boat have on board systems (other than conventional turnbuckles) to adjust the forestay or the mast foot? If so, will the boat use these systems while racing?

It is impossible to detail every point. Measurers are simply asked to check whatever detail is possible whenever possible.

When measuring one-off boats, or endorsement generally, measurers are asked whenever possible to take photographs (keel, rudder, interior, etc) for inclusion in the boat's file.

## APPENDIX 1. WEIGHING ON COMPRESSION LOAD CELLS

It is recognised that weighing on compression load cells is becoming more and more attractive from a logistical and financial perspective. However, where possible it is always recommended that single point lift be the preferred option. Event organisers may require competitors to be weighed prior to an event. In such cases the recommendation is that such boats are weighed using the single point lift method.

As with all measurement, accuracy and repeatability is paramount. There are 2 distinctly different methods of weighing on compression load cells: lowering the boat into a cradle supported on compression load cells and driving a travel lift onto pressure pads. Only the first method, lowering the boat into a cradle is acceptable for IRC weighing. Driving a travel lift onto pads and weighing the combined weight of the travel lift and boat, then deducting the weight of the travel lift is not acceptable but is currently under review.

1. There appear to be two types of compression load cells, one of which has the sensor at the top, the other has the sensor at both ends. This latter type is not desirable because it requires a totally flat clean surface underneath as well as on top. If the latter type is to be used, each cell **MUST** be stood on a clean flat steel plate.
2. Flat level ground appears to be important. If not, the load may be unevenly shared between corners (which in itself shouldn't matter) but may also vary during the weighing which will produce false readings.
3. There is also a possibility that non parallel ground/cradle surfaces may introduce errors into the readings.
4. The bearing point on each cell must be cleanly in contact with the underside of the cradle. Placing timber or other compressible material between the load cell and the cradle can result in the load being shared by the structure of the cell rather than only by the load sensitive part. Additionally, it is important that the bearing point on each cell bears against a flat section of cradle. Discontinuities in the cradle surface (created by welds, joints etc) must be avoided.
5. Wind can have an effect. Windage on the rig of a boat will change the distribution of load in the cradle and hence the reading on each individual cell. The total net effect should be small, BUT when each cell has to be read individually, they really then need to be read at exactly the same moment. The effects of this can be mitigated in the case of individual read-outs by laying out the read-outs in such a way that it is possible to see all of them simultaneously. Cross variation can then be seen and noted.
6. If possible use equipment with the read out from each of the four cells electronically combined. Read (if possible record) the read out at regular intervals so that a mean reading can be found. In the case of a load cell read out combining electronically the signals from each cell, windage and uneven ground effects should be minimised. This does not make them any the less undesirable.
7. As ever, dunnage and packing used when the boat is in the cradle must be replaced on the cradle for tare purposes.
8. For practical reasons, when the boats is lowered into a cradle the travel lift straps will generally remain around the boat during the weighing. Obviously, care must be taken to ensure that they are slack.
9. Accuracy. Given that 3 or 4 cells are used as opposed to 1 for a single point lift, the potential for inaccuracy is increased. Cells of the highest possible accuracy, rated as appropriately as possible for the gross weight become of greater importance.
10. Range. While for maximum accuracy, we want cells of combined total capacity as close as possible to the gross weight, care needs to be taken because placing the boat in the cradle may result in a very uneven load distribution. This should be taken account of in sizing the cells.

## APPENDIX 2. OVERHANGS & WEIGHING OF SUPERYACHTS

It is recognised that for very large boats, with **Hull Length** of 30.5m and greater, it is generally impractical to bring the boat into measurement condition, and not possible to weigh the boat by single point lifting. It is also extremely difficult and costly to weigh the boat on pressure pads, as this may require a dry dock and extremely substantial custom built cradle. As such the following alternative is permitted with prior approval of the Rating Authority for these very large boats. It may also be used for smaller but very heavy boats with the prior approval of the Rating Authority.

As with all measurement, accuracy and repeatability is paramount. This method takes time, so accept that and don't rush it. It is imperative that the condition of the boat is recorded accurately as outlined below:

1. Ensure the Rule Authority is aware of the method being used, and that the Rating Authority has sanctioned it.
2. Ensure that a set of hull lines are provided by either the designer or from an ORC IMS measurement or similar, in a format that can be used to calculate the displacement and trim changes in the appropriate software. Discuss this with the designer and Rule Authority first.
3. Ensure that the boat captain is aware of the process and the time required to complete the work. Also make the boat captain aware that the closer to empty the boat is, the less chance for error there is. So ask them to empty the boat as far as reasonably possible. If sails, or other heavy items which cannot be easily weighed are to remain on board, ask the boat captain to provide weights for these items. For very large sails the sail maker will have a record of the delivery weights at least, and will probably have a record of the fully dressed sail weight. Remember to include battens where necessary. Ask that any bow anchor be dropped to the seabed if possible with a lanyard left attached only for recovery, ensuring that there is no weight on the line.
4. In an ordered manner record the fore and aft location as well as the weight of everything that should not be included in measurement condition. It is best to start at the bow and work aft, first above decks and then below decks, or vice versa, provided no location is overlooked. Fore and aft location can be recorded relative to the mast for simplicity. Multiple items, such as drinking water bottles can be counted and multiplied by the volume. Tankage can be recorded from the gauges, but remember to also record the location of each tank. It is best to compile this record on a spreadsheet so that the mean longitudinal location of the combined weigh can be calculated relative to the mast.
5. Once all is recorded the mooring lines should be eased as much as possible and the measurements  $y$  and  $h$  are recorded at the bow and stern as accurately as possible. For this the conditions have to be at least as good as a normal overhang measurement.
6. Provide the full information to the designer and Rule Authority so that the measured displacement and overhangs can be calculated. From this the recorded weight can then be deducted from the calculated location and the weight and overhangs adjusted and recorded for use in the IRC calculation.
7. Record as much as possible with a camera, with the boat captain's permission. Also recognise that the crew may live on the boat full time. Respect their privacy in areas of the boat where their personal belongings are kept, as well as the privacy of the owner.
8. This is a costly and time consuming process. As such ensure as much as possible is prepared beforehand, and ensure that the Rule Authority is fully aware of what you are doing. The Rating Authority will be at hand to answer any questions whenever possible. Do not be afraid to ask.



## APPENDIX 3. IRC ENDORSEMENT – PROCESS, MEASUREMENT & DATA STANDARDS

### A3.1 Preamble

An 'endorsed' IRC certificate is one for which the data on the certificate has been audited and if necessary verified by measurement (official measurers) or other methods. The IRC Congress agreed that a set of common standards for the IRC Rating Authority and Rule Authorities to apply when endorsing a boat's IRC certificate should be developed and published.

Generally, IRC is a self-measurement system. There is thus no general requirement for an owner to have their boat officially measured or weighed unless either they choose to do so, or the Rule Authority (ie the local IRC body) and/or an Organising Authority for a race requires official measurement, generally resulting in an endorsed IRC certificate.

As a part of this, in future, the nomenclature on an endorsed IRC certificate issued by either the RORC Rating Office or the YCF Centre de Calcul will be:

**ENDORSED** meaning that the data has been audited by a Rule Authority with any measurement by a measurer recognised by the Rule Authority.

Within the guidelines below Rule Authorities are given some options for sources of data. This recognises that circumstances vary from country to country, that some owners are prepared to expend more time and effort than others, and that for instance weighing a large boat may be impractical. The options offered cater for these while at the same time not generally compromising the validity of a boat's data and hence her endorsed certificate.

It is a fundamental prerequisite of this that responsibility for appointment and training of measurers and quality of measurement data generally lies with each Rule Authority. Attention is drawn to the IRC Measurement Manual available from the IRC website, [www.icrating.org](http://www.icrating.org). Additional material to aid Rule Authorities and measurers is also available direct from the Rating Authority.

### A3.2 Process

An owner wishing to have their certificate endorsed first contacts their local Rule Authority. **The Rule Authority carries responsibility for auditing the boat's data file and for defining what, if any, data is to be verified.** In doing this, the data and measurement standards below shall be applied. If these standards are not applied, then the Rating Authority must be advised and an endorsed certificate will not be issued

On return of the data from the measurer, or other defined source, the Rule Authority will review the data and confirm that it is satisfied that an endorsed certificate can be issued. The data is then forwarded to the Rating Authority accompanied by a request to issue an endorsed certificate. Only then will the Rating Authority issue an Endorsed certificate.

**The Rating Authority reserves the right at its absolute discretion to refuse to issue an endorsed certificate if it is not satisfied in any respect with the data submitted by a boat through her Rule Authority.**

### A3.3 Measuring Equipment

While measurement methods are generally beyond the scope of this, the following shall apply.

#### A3.3.1 Load Cells

Load cells for single point lift weighing shall have a quoted accuracy of +/-0.2% of maximum capacity or equivalent and discrimination of not less than 10 kg. ie, a 10 tonne load cell should have a quoted accuracy of +/- 20 kg, and a 20 tonne cell, +/- 40 kg. Load cells shall be calibrated at least once per year.

A load cell should not be used to weigh a boat weighing less than 15% of the maximum capacity of the load cell, ie 1500 kg for a 10 tonne cell. Rule Authorities may waive this requirement on an individual case basis.

Compression load cells should generally follow the above standards. It is however recognised and noted that the ultimate accuracy of weighing on compression load cells is a function of the combined accuracy of all the cells rather than the accuracy of each individual cell and also of the methodology adopted. Rule Authorities are therefore advised to exercise care in approving compression load cells.

### **A3.3.2 Linear Measurements**

Tape measures and measuring rules built to CE category 2 or equivalent standards are acceptable. Tape measures should be steel. Fabric tapes are not generally acceptable.

### **A3.4 Sources of Data**

#### **A3.4.1 General**

<b>Generally Acceptable</b>	Weight	Hull and Appendages	Rig	Sails
Measurement carried out by an authorised measurer using equipment complying with defined standards.	N/A	✓	✓	✓
Single point weighing carried out by an authorised measurer using a load cell complying with defined standards.	✓	N/A	N/A	N/A
If available, standard design data and light weight defined by the Rating Authority.	✓	✓	✗	✗
Unless prescribed otherwise by an IRC Rule Authority, sail measurement by a World Sailing In-House Certified (IHC) sail loft.	N/A	N/A	N/A	✓
Data supplied by an approved sail measurer.	N/A	N/A	N/A	✓

<b>Acceptable at the discretion of a Rule Authority</b>	Weight	Hull and Appendages	Rig	Sails
Weighing on compression load cells carried out by an authorised measurer using load cells complying with defined standards.	✓	N/A	N/A	N/A
Measurement carried out by a specially appointed (by the IRC Rule Authority) measurer or sail measurer.	N/A	✓	✓	✓
Single point weighing or weighing on compression load cells carried out by a specially appointed measurer using load cells complying with defined standards.	✓	N/A	N/A	N/A
Weight derived from freeboards measured by an acceptable method, calculation and declaration by the naval architect.	✓	N/A	N/A	N/A
ORC or ORR DSPM if 2013 or more recent. If earlier than 2013: minus measurement inventory only if a measurement inventory is available	✓	N/A	N/A	N/A
Data derived from an in date or recently expired ORC, ORR or other measurement certificate.	N/A	✓	✓	✓

<b>NOT acceptable</b>	Weight	Hull and Appendages	Rig	Sails
Owner or manufacturer declaration.	✗	✗	✗	✗
Registered Tonnage.	✗	N/A	N/A	N/A
Weighing on crane built in Loadcell.	✗	N/A	N/A	N/A



Weighing in travel hoist.	<input type="checkbox"/>	N/A	N/A	N/A
---------------------------	--------------------------	-----	-----	-----

**A3.4.2 One Designs Previously Approved by the Rating Authority**

One designs previously approved as such by the Rating Authority may have their certificates endorsed without further measurement on declaration by the owner that the boat holds and is in compliance with her one design class certificate.

**A3.5 Retention of Endorsed Status**

When a boat changes any data, to retain the endorsed status of her certificate, the changed data shall be verified by a method approved by the Rule Authority and included in paragraph 4.1. above.

## APPENDIX 4. MAINSAIL MEASUREMENT

What is being measured? **Half Width, Three Quarter Width and Seven-Eighths Width**

What are these? The distances from the **Half, Three Quarter, and Seven Eighths Leech Points** to the **Luff**.

In practice:

1. Lay the sail out flat on a suitable floor.
2. Establish **head point** and **clew point** as shown by the diagram.

If there is local curvature and/or irregularity in the **sail edge** leading into a corner point, the extension of the sail edge shall be found using a batten as specified in ERS H.5.4.

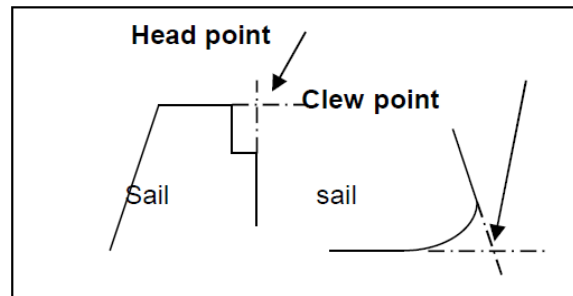

The batten shall be a standard 1m World Sailing blue batten unless the measurer cannot achieve a consistent measurement in which case the measurer shall use a batten of consistent bend characteristics and length appropriate to the sail being measured. The measurer shall provide photographs to the Rating Authority.

3. Fold the **head point** to the **clew point**. Mark the fold in the **leech**. That is **half leech point**.
4. Fold the **head point** to the **half leech point**. Mark the fold. That is **three quarter leech point**.
5. Fold the **head point** to the **three quarter leech point**. Mark the fold. That is **upper leech point**.

Measure from each **leech point** to the nearest point on the **luff**. These distances are the  **mainsail widths**.

7. Check for **sail leech hollows**. See ERS G.2.4 and H.5.2
8. Add any **hollow (A)** to each measured **Width (B)** to get the final **widths**.

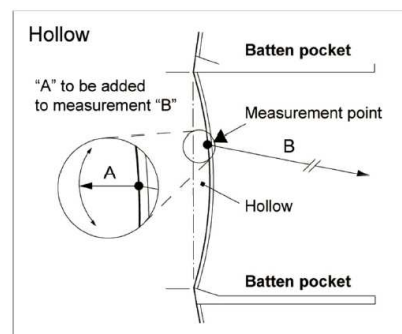

References:

Equipment Rules of Sailing. <http://www.sailing.org/documents/isaf-equipment-rules.php>.

G.4.1 and G.4.2 define **Clew Point** and **Head Point**.

G.5.2, G.5.3 and G.5.4 define **Half Leech Point, Three Quarter Leech Point** and **Seven Eighths Leech Point**

G.7.5, G.7.6, and G.7.7 define **Half Width, Three Quarter Width** and **Seven Eighths Width**.

G.2.4 and H.5.2 address **Sail Leech Hollows**.

H.5.4 defines Extended as necessary.

## APPENDIX 5. HEADSAIL & FLYING HEADSAIL MEASUREMENT

What is being measured? **Luff Length, Luff Perpendicular (HLP), Half Width, Three Quarter Width and Seven Eighths Width, headsail foot offset.**

What are these? The length of the **Luff**, the distance between the **Clew Point** and the **Luff**, and the distances from the **Half, Three Quarter and Seven Eighths Leech Points** to the **Luff**.

In practice:

1. Lay the sail out flat on a suitable floor.
2. Establish **head point, tack point** and **clew point** as shown by the diagram.

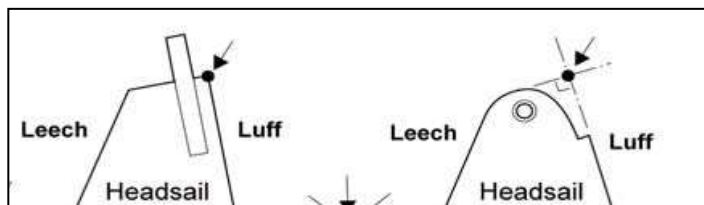

If there is local curvature and/or irregularity in the **sail edge** leading into a corner point, the extension of the sail edge shall be found using a batten as specified in ERS H.5.4.

The batten shall be a standard 1m World Sailing blue batten unless the measurer cannot achieve a consistent measurement in which case the measurer shall use a batten of consistent bend characteristics and length appropriate to the sail being measured. The measurer shall provide photographs to the Rating Authority.

3. Straighten the **luff** and pulling firmly measure the **luff length** between the **head point** and the **tack point**.
4. Measure **LP** from the **clew point** to the nearest point on the **luff**.
5. Fold the **head point** to the **clew point**. Mark the fold. That is **half leech point**.
6. Fold the **head point** to the **half leech point**. Mark the fold. That is **three quarter leech point**.
7. Fold the **head point** to the **three quarter leech point**. Mark the fold. That is **upper leech point**.
8. Measure from each **leech point** to the nearest point on the **luff**. This will give the **half, three quarter and upper widths**.

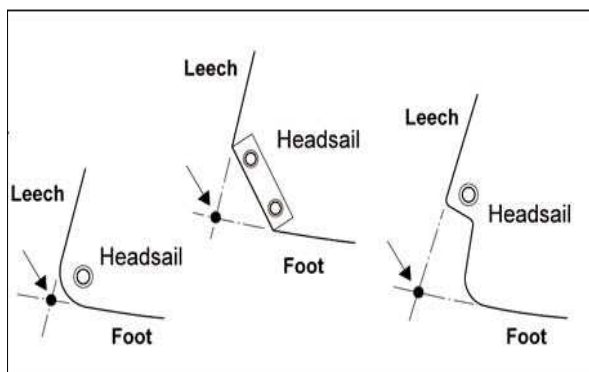
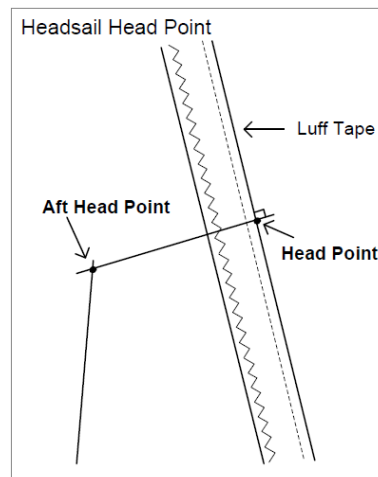



9. Check for **sail leech hollows**.  
 See ERS G.2.4 and H.5.2

10. Add any **hollow** (A) to each measured **width** (B) to get the final **widths**.

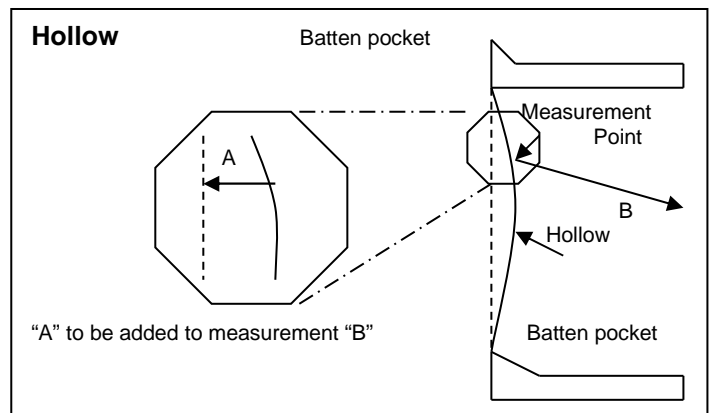

References:

Equipment Rules of Sailing. <http://www.sailing.org/documents/isaf-equipment-rules.php>.

G.4.1, G.4.2 and G.4.3 define **Clew Point**, **Head Point**, and **Tack Point**.

G.5.2, G.5.3 and G.5.4 define **Half Leech Point**, **Three Quarter Leech Point** and **Upper Leech Point**.

G.7.3 defines **Luff Length**.

G.7.5, G.7.6 and G.7.7 define **Half Width**, **Three Quarter Width** and **Upper Width**.

G.7.11 defines **Luff Perpendicular**.

G.2.4 and H.5.2 address **sail leech hollows**.

H.5.4 defines Extended as necessary.

## APPENDIX 6. HEADSAIL FOOT OFFSET

To prevent the practice of reducing headsail dimensions and the corresponding area calculations by exaggerating the curve of the foot artificially raising the tack and clew, **Foot Offset** is controlled.

This is referenced in IRC Rule 21.7.1

If foot offset is greater than 7.5% of LP, then foot offset shall be declared and foot offset shall be added to LL in the calculation of HSA.

What is **Foot Offset**?: - It is the maximum offset distance between the edge of a headsail foot and a straight line between tack point and clew point

- How is it Measured:
- 1 – Lay out the sail flake as necessary so that the foot area is flat on the floor.
  - 2 – Determine the tack and clew points and measure LP.
  - 3 – Run a string line from tack to clew.
  - 4 – Visually determine the position of the maximum distance from string line to headsail foot, measure perpendicular to the string line from headsail foot to string line at this point.
  - 5 – Repeat the measurement from string line to headsail foot in numerous locations to ensure that the maximum dimension has been determined.
  - 6 – Foot Offset % is calculated by  $100 * \text{Foot Offset Measurement} / \text{LP}$
  - 7 – If the foot offset is greater than 7.5% the dimension should be submitted with the headsail data on the measurement input form.

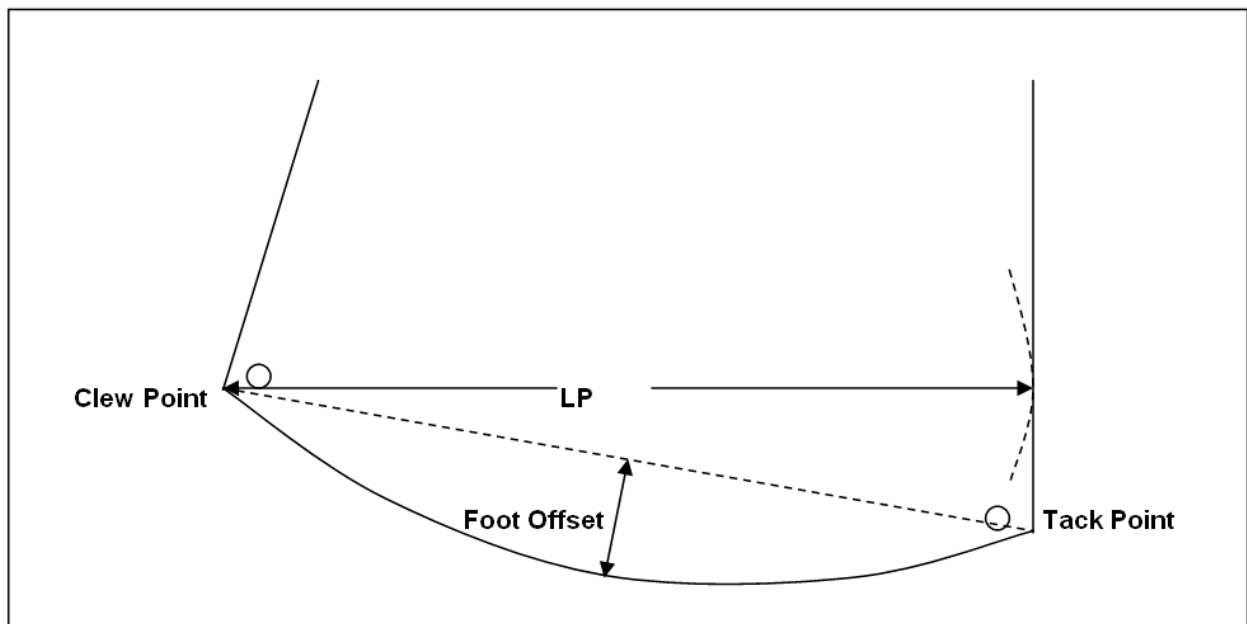

## APPENDIX 7. SPINNAKER AND FLYING HEADSAIL MEASUREMENT

What is being measured? Spinnaker: **Luff length, leech length, foot length** and **half width**.  
 Flying Headsail: **foot length** and **half width**.

What are these? The lengths of the **luff, leech** and **foot** and the distance from the **half luff point** to the **half leech point**.

In practice:

1. Lay the sail out flat on a suitable floor.
2. Establish **head point, tack point** and **clew point** as shown by the diagram.

Note that for a symmetric spinnaker, **luff/leech** and **tack point/clew point** are interchangeable.

If there is local curvature and/or irregularity in the **sail edge** leading into a corner point, the extension of the sail edge shall be found using a batten as specified in ERS H.5.4.

The batten shall be a standard 1m World Sailing blue batten unless the measurer cannot achieve a consistent measurement in which case the measurer shall use a batten of consistent bend characteristics and length appropriate to the sail being measured. The measurer shall provide photographs to the Rating Authority.

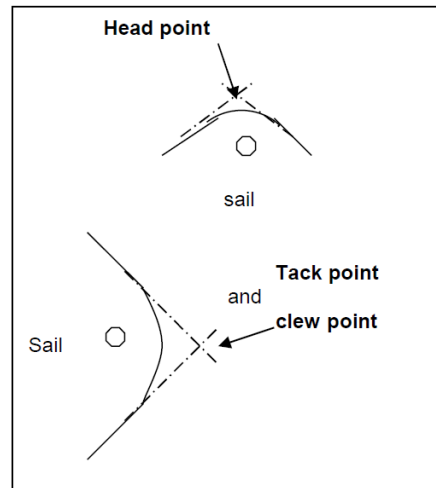

3. Straighten the **luff** and measure the **luff length** between the **head point** and the **tack point**.
4. Straighten the **leech** and measure the **leech length** between the **head point** and the **clew point**.
5. Straighten the **foot** and measure the **foot length** between the **tack point** and the **clew point**.
6. Fold the **head point** to the **tack point**. Mark the fold. That is **half luff point**.
7. Fold the **head point** to the **clew point**. Mark the fold. That is **half leech point**.
8. Measure from the **half luff point** to the **half leech point**. This will give you **half width**.

References:

Equipment Rules of Sailing. <http://www.sailing.org/documents/isaf-equipment-rules.php>.

G.4.1, G.4.2 and G.4.3 define **clew point, head point**, and **tack point**.

G.5.2 defines **half leech point**.

G.5.7 defines **half luff point**.

G.7.1, G.7.2 and G.7.3 define **foot length, leech length** and **luff length**.

G.7.5 (b) defines **half width**.

H.5.4 defines Extended as necessary.

## APPENDIX 8. BULB WEIGHT MEASUREMENT

For several years now IRC has required bulb weight to be provided for keel types 10, 11 and 12.

There are several methods which may be used to establish this, with varying levels of accuracy and reliability. In general we will not require this to be measured and if you do plan to measure it please contact the Rule Authority to confirm that it is necessary and which method is to be used as a preference. We will also base the rating calculation on the most accurately understood data that we have. However, if needed, the methods used are detailed below:

### A8.1 Weigh the bulb.

Weighing the bulb is the most rigorous method. The bulb needs to be weighed separately from the keel fin, normally at a stage of manufacture and normally this is only possible when a new keel is being assembled. This needs to be done in exactly the same way as boat weight, using a single point lift with an appropriately calibrated and tested load cell. Allowance may need to be made for lifting eyes and corrector weight pockets, along with any additional lead that may be fitted into the fin to bulb recess.

The IRC definition of Bulb Weight is:-

The weight of the **Bulb** and any part of the **Keel** below the upper surface of the bulb (including connection plates, under-fin spacers and infills)

This is the weight of everything shown below the red line in the picture below;



It is important to document what is included. Note details & photograph where possible the items for future reference. The required weight will be made up of a combination of the following components:

- Bulb Casting
- Section of the keel fin that is below the upper surface of the bulb
- Bulb to keel fin attachment bolts including washers and any plates
- Under-fin spacers plates that fit between the keel fin and bulb
- Ballast for pockets & infill pieces

#### A.8.1.1 Bulb Casting

Typically, a bulb is weighed by hanging the bulb casting from a loadcell. In the same procedure for weighing a hull. Weigh at least twice to check for consistency and don't forget to correct for the weight of the strops and any other lifting gear below the loadcell.



Section of the keel fin that is below the upper surface of the bulb

The keel fin weight below the upper surface of the bulb is not determined by weighing. Measurement is required to determine the volume of material and the weight is calculated using the density of the keel fin material.

Either the volume of the fin foot (length, breadth & depth) can be measured or the recess in the bulb casting. If measuring the recess in the bulb casting checks should be made to ensure that the recess is not over length to allow a longitudinal position to be varied. If this is the case, then determine if the extra length check will be filled with lead or foam blocks.

The calculated volume should be submitted with the weight of the bulb and other components to allow the final full bulb weight to be calculated. The volume of the bolt holes and any other cut outs may be deducted from the overall volume.

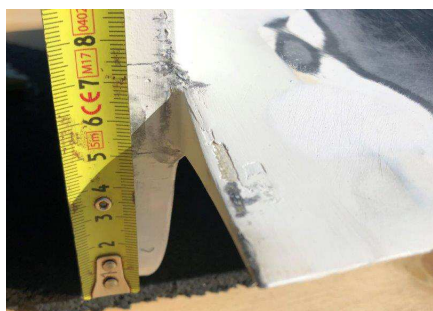
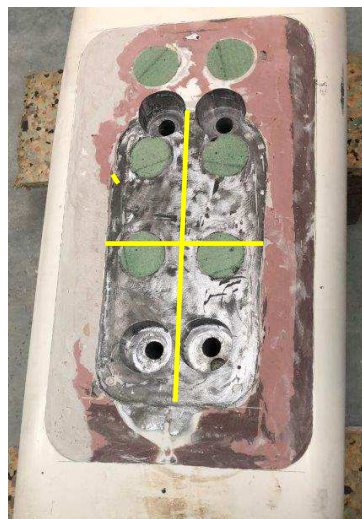
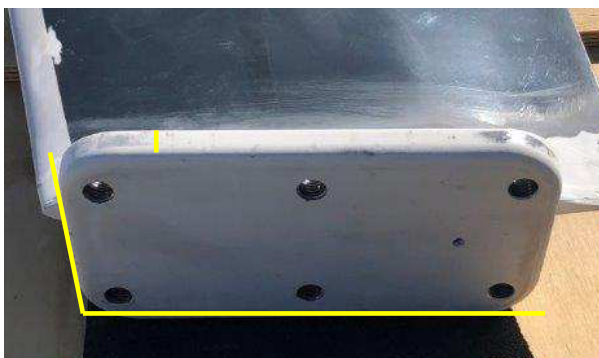

Bulb to keel fin attachment bolts including washers & any plates.

These can either be weighed individually or included in the bulb casting weight. Either way it is important to compare the number of bolts with the number of holes to make sure that no bolts are missing.



**A.8.1.2 Under-fin spacer plates that fit between the keel fin & bulb**

These can either be weighed individually or included in the bulb casting weight. Either way it is important to note the number of plates and their thickness, typically these plates are used for final adjustments to a determined draft measurement.



**A.8.1.3 Ballast for pockets & infill pieces**

These can either be weighed individually or included in the bulb casting weight. Often bulbs are machined with pockets to allow the final weight & trim to be adjusted, especially if these are partially filled it is important to note the ballast that is included these pockets for future reference.



This is generally only an option for top level programs of new builds, and is not something we can rely upon being an option in most cases.

**A8.2 Designer/builder declaration.**

Most boat builders these days will be purchasing the keel from a sub-contractor. In these cases it is common practice for the principle builder to require proof of weight in the purchase agreement so that they can confirm they have got what they have asked for and that it coincides with the designer's

specification. Similarly, the designer will have a target weight for the bulb even if they have not required proof of weight.

Again, whilst this information is likely to be somewhere for most boats with these keel types, records of it may be difficult to obtain for older builds and where modifications have been made. We also never really know whether an owner has filled or emptied pockets, or altered the bulb. And often the original designer and builder may not be aware of changes made. It is however a good reference point and in the vast majority of cases will represent the actual bulb weight well.

### A8.3 Volume measurement.

There are several methods that can be used, from the more complex approach of a full laser scan or photogrammetry (photo below) to simply measuring length and circumference at selected points along the length. From this a combination of cross-sectional area and Simpsons rule can be used to calculate the volume of the bulb.

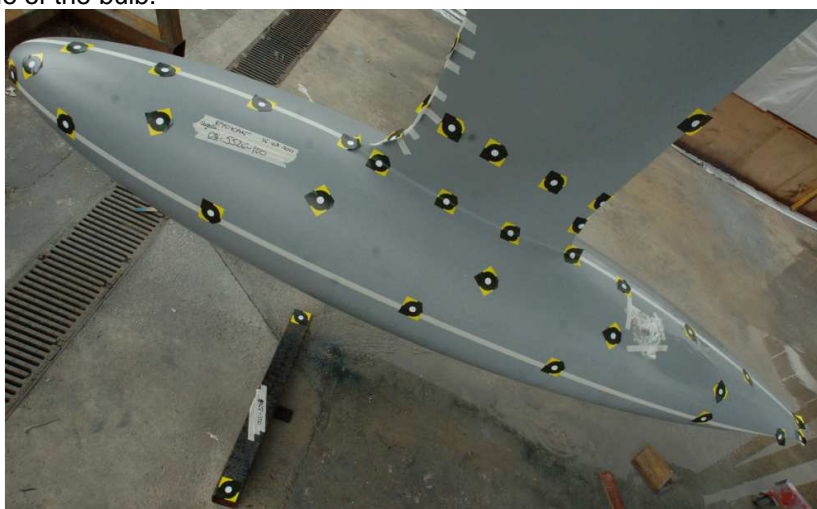

The inaccuracies in these method are:

- |                               |   |
|-------------------------------|---|
| Density of the bulb.          | This needs to be estimated. However, deviation is likely to be small.   |
| Unaccounted pockets.          | There are likely to be voids in the bulb for attachments and possible adjustment pockets. If detail is known of these then they can be accounted for.   |
| Internal structure.           | Some keels may have internal steel cages. These will reduce the density slightly, but it is best to ignore these unless details are available. But if details are available then we will likely also have full bulb weight details.                           |
| Defining the top of the bulb. | With a sharp intersection of the bulb to fin joint this is easy to establish. But with a large radius then some assessment is needed. Best to stop the crane at the bottom of the radius, as the joint is likely to be primarily filler and not made of lead. |

For clarity, IRC considers the definition of the bulb in the following way:

IRC Bulb Weight refers to the **Bulb** as defined by the World Sailing Equipment Rules of Sailing. This document is provided as clarification that all under-fin spacers and in-fills shall be included in the total Bulb Weight.

The ERS E.1.2(e) defines **Bulb** as

A **hull appendage** containing **ballast** at the bottom of another **hull appendage** primarily used to affect stability.

The ERS C.6.3(f) defines **Ballast** as

Weight **installed** to influence the stability, flotation or total weight of the **boat**.



The ERS E.1.1 defines **Hull Appendage** as

Any item of equipment – including the items listed in E.1.2– which is:

wholly or partly below the **sheerline** or its extension when fixed or when fully exposed if retractable, attached to the **hull** shell or another **hull appendage**, and used to affect: stability, leeway, steerage, directional stability, motion damping, trim, displaced volume.

Any of the following shall be included in the **hull appendage**:

**corrector weights**,  
integral **ballast**, and  
associated **fittings**.

Therefore, all under-fin spacers and in-fills shall be included in the total Bulb Weight. See Appendix 9 for more information.



## APPENDIX 9. LEAD IN KEEL FIN S

IRC Rule 19.6 states:

*Any material in the keel fin of a keel type 10, 11 or 12 with a specific gravity greater than 8.0 (e.g. lead) shall be declared in writing.*

With the introduction of the rating of bulb weight in IRC for keel types 10 to 12 over the past few years, and the addition of the bulb weight to the IRC certificate in 2016, the focus on the optimum approach to weight distribution within the keel for these keel types has become sharper.

It has become apparent that as ballast in the keel bulb is rated, but any ballast that is transferred to the lower section of the keel fin is not, there is an incentive for teams to accept a slight raising of the vertical centre of gravity for a reduction in rating that is greater than the performance reduction.

The IRC Technical Committee has therefore agreed that for IRC 2017 the weight of any materials with a specific gravity greater than 8.0 which are found in the keel fin of boats with keel type 10 to 12 and keel fin material of steel, iron or composites shall be declared.

Please note that this applies to keel types 10, 11 and 12 only

## APPENDIX 10. FOILS MEASUREMENT

IRC definition for foil measurement is as follows:

### LIFTING FOILS:

No. of Foils: The maximum number of foils that may be actively in use simultaneously.

With the **boat** upright in **flotation trim**, for each foil:

Foil Span: The maximum transverse distance outside the hull shell between any two points on the foil in its fully extended position.

Foil Chord: The maximum longitudinal distance of the foil.

The IRC Rating Authority reserves the right to require additional detail to be supplied and also to modify the above definitions on a case by case basis in accordance with IRC Rule 2.8.

Examples for foil measurement are below:

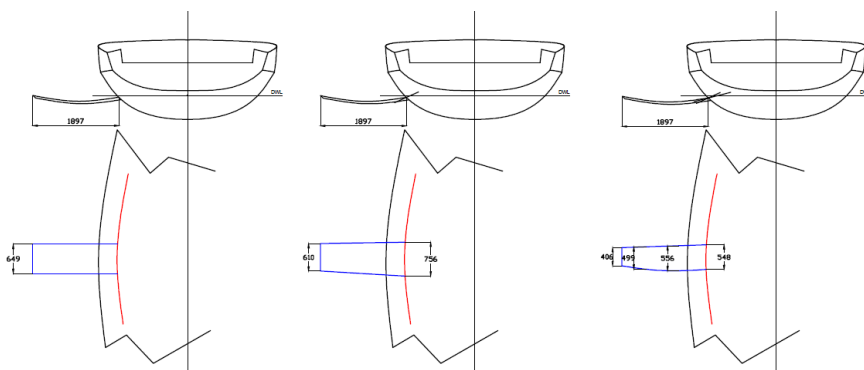

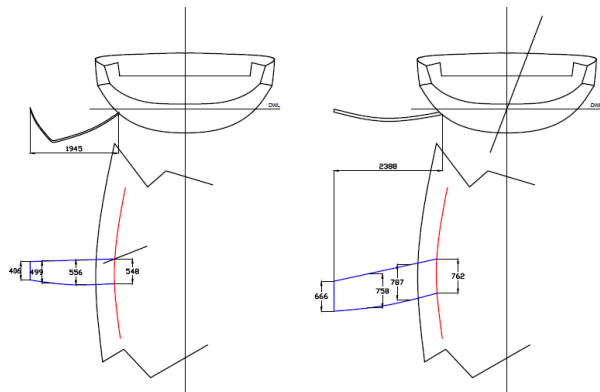

## APPENDIX 11. LIST ANGLE MEASUREMENT

The measurement of List Angle is to determine the maximum angle of heel due to the presence of either movable ballast (typically canting keel) or variable ballast (typically water ballast).

IRC Rule 22.3.2 defines the requirement:

22.3.2 **List angle** is measured in the **boat weight** condition (see Rule 17) with any additional **variable ballast**. There is no limit to the **list angle** with ballast tanks fully filled on one side of the **boat** and/or with **moveable ballast** moved fully to one side.

IRC Rule 22.3.5 defines the requirement for boats with both movable and variable ballast. In this case the list angle is only required to be measured specific to the movable ballast, however the volume of the variable ballast needs to be determined and declared.

### A11.1 Equipment

- Inclinator or Digital Spirit Level reading to at least the nearest 0.1°
- Flow Meter & Pump – Optional if available to measure volume of water in the tank.

### A11.2 Preparation

- The boat should be afloat in the **boat weight** condition (see Rule 17), any items that may move as the boat heels should be secured to ensure that they remain in position and do not influence the measurement. e.g Boom secured to prevent swinging.
- Consideration should be given to any current and/or prevailing wind to prevent these environmental factors impacting the result. The measurement should be carried out in light conditions but additionally the boat should be positioned to sit bow or stern into the wind ideally with the ability to rotate with any change in wind direction.
- Water and holding tanks must be empty, fuel tanks should ideally be close to empty.
- Measurements should be taken with no persons aboard the boat, if reading measurements is not possible from adjacent pontoons the measurer should be positioned in a dinghy.
- The list angle with variable ballast should be measured using salt water (1.025 Density) however if fresh water is used additional weight should be used to correct for the weight difference – 2.5kg per 100 litres



### **A11.3 Movable Ballast**

1. Centre the keel. Check that the keel is centred by comparing the angle of the keel head to the surrounding structure or by measurement of the keel head relative to structure port and starboard.
2. Measure the upright angle of heel.
3. Swing the keel to starboard & measure the heel angle.
4. Swing the keel to port & measure the heel angle.
5. The declared list angle is the average of the measured port list angle and the measured starboard list angle.

If the range of **movable ballast** is limited as permitted by IRC Rule 22.3.6. The measurer should photograph / take notes on the installation with reference measurements on the position of mechanical limit to allow for future checks.

22.3.6 A physical, mechanical limit shall be fitted to all **moveable ballast** system to prevent it being moved further than the position for the declared **list angle**. Such a system shall not rely on sensors or measurement to prevent the declared **list angle** being exceeded unintentionally.

### **A11.4 Variable Ballast**

1. Ensure all tanks are empty, measure the upright angle of heel.
2. Check that the transverse transfer valves on centreline are closed. If the system does not have centreline valves, close the valves as close to the centreline as possible and note the distance off centreline & pipe diameter.
3. Fill starboard tank(s) with sea water with an external pump through the tank vent or using the boats onboard pump system - Check that all compartments are full with no air pockets.
4. Measure angle of heel with the starboard tank(s) full. Starboard list angle is the difference between this result and the upright heel angle measured in step 1.
5. Empty all starboard tank(s).
6. Check the boat is back to upright comparing the heel angle to the angle measured in step 1.
7. Fill port tank(s) with sea water with an external pump through the tank vent or using the boats onboard pump system – Check that all compartments are full with no air pockets.
8. Measure angle of heel with the port tank(s) full. Port list angle is the difference between this result and the upright heel angle measured in step 6.
9. Empty all port tank(s).
10. Check boat is back to upright comparing the heel angle to the angle measured in steps 1 & 6.
11. Check for consistency in the results especially in the upright heel angle measured in steps 1, 6 & 10. If in doubt repeat the measurements.
12. The declared list angle is the average of the port list angle and the starboard list angle.



# NOTES